

REVISIONS				
ZONE	REV.	DESCRIPTIONS	DATE	APP.

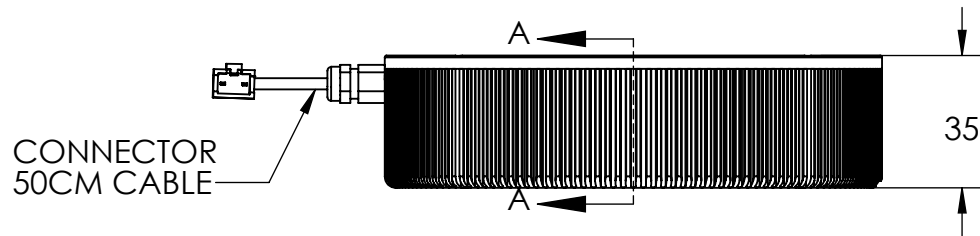

SECTION A-A
SCALE 1 : 2

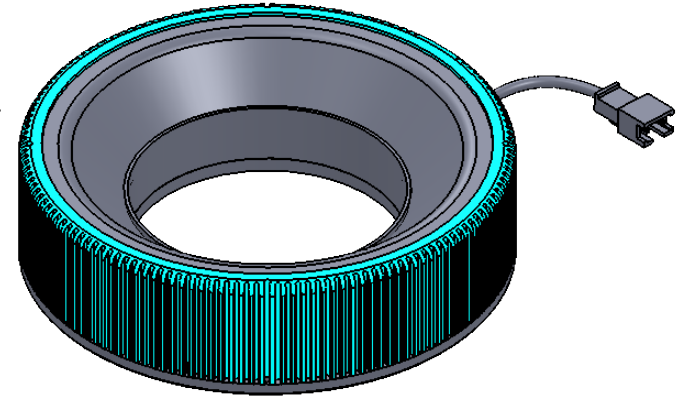
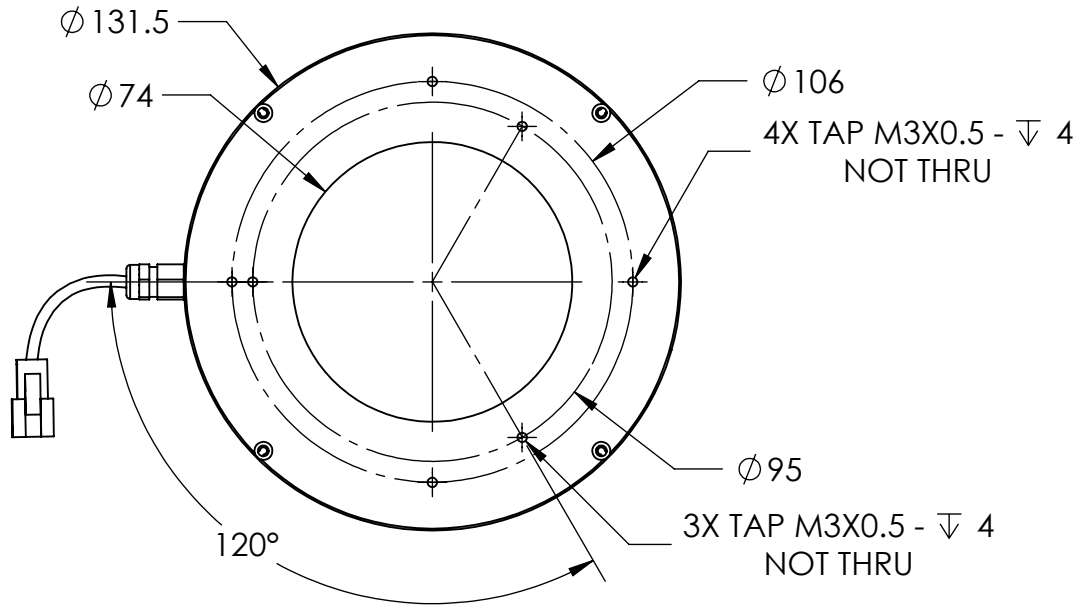
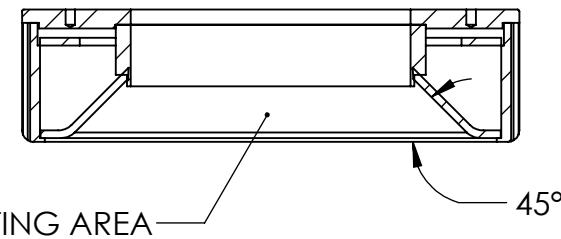

DESIGN BY	AFIZA	UNIT:	PRODUCT SERIES: RLF3 SERIES		
CHECK BY	KB TAN	MM			
DATE	29/12/2016	REVISION:	TITLE	DRAWING LAYOUT	COLOUR: - -
MATERIAL	-	01	PART NO	RLF3-45-130-1-X	VOLTAGE: - -
FINISHING	-	SCALE:	DWG NO	-	CURRENT: - -
QTY	1	1 : 1	POWER: - -		
					SHEET 1 OF 1